

BEST CONTACTS FOR YOUR SUCCESS



**Telegärtner**

KARL GÄRTNER GMBH

NETWORKING COMPONENTS

COAXIAL CONNECTORS

CABLE ASSEMBLIES

PRECISION TURNED PARTS

PLASTIC INJECTION MOULD PARTS

INDUSTRIAL ELECTRONICS

**Simpler all over.  
Simpler all round.**



Cat. 6A

10 GBE

500 MHz

fully shielded

PoE+

Cat. 8.1

40 GBE

Data Voice

**MFP8**

Field assembly RJ45 plug series



## MFP8 Cat.6<sub>A</sub>

Full-metal RJ45 field-assembly plug featuring four-step cable relief.

Most suited for data center, enterprise and residential cabling.

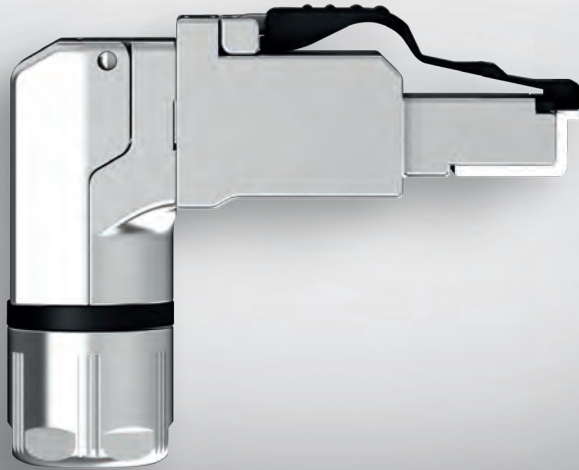

## MFP8-4x90 Cat.6<sub>A</sub>

Full-metal RJ45 field-assembly plug featuring right-angle cable entry from four directions and metallic cable strain relief.

Most suited in confined spaces like sitch or control cabinets.

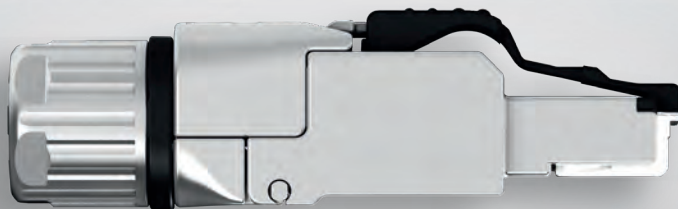

## MFP8 IE Cat.6<sub>A</sub>

Full-metal RJ45 field-assembly plug featuring metallic cable strain relief for cable outer diameter up to 10 mm.

Most suited for assembly with various kinds of industrial, installation or patch cables.

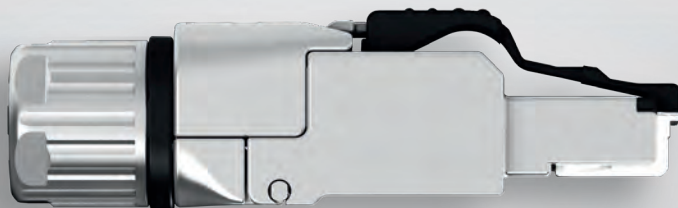

## MFP8 Cat.8.1

Full-metal RJ45 field-assembly plug featuring metallic cable strain relief for cable outer diameter up to 10 mm.

Most suited for assembly with various kinds of installation or patch cables for highspeed data center applications.

## Less fuss. More flexibility.

Here's the situation: An existing network needs extending. A cable link needs to be repaired or replaced. A peripheral device needs to be connected quickly. Your customer expects a fast and reliable solution but you don't have a cable assembly ready at hand. Sound familiar?

Now you can keep cool when faced with such demands – with the field assembly MFP8 RJ45 plug series developed by Telegärtner.

The MFP8 plug series enables time-saving and efficient on-site assembly for all networks, from Voice right through to 40 Gigabit Ethernet. It can be assembled on all standard types of cable in just 60 seconds – and no special tools are required.

Whether in the office, data centers, in industry or in home networks – the MFP8 plug series offers unprecedented flexibility and saves time and money on installation, repairs and maintenance.

## Simpler all over: MFP8 applications

The field assembly MFP8 plug series is the number one choice whenever efficient and reliable connections are needed without major expense or effort, whether for classic cabling systems in office buildings, data centers, in industry or for home cabling systems. Needless to say, it also supports Power over Ethernet plus (PoE+).

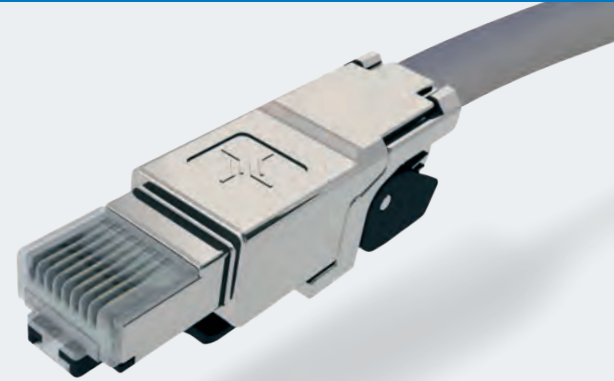

### Office/premise cabling and data centers

With the MFP8 plug series, installers and network professionals now have access to RJ45 plugs which will enable them to respond with speed and flexibility, even at short notice, to any requirement, be it cabling for workstations, connections for equipment or backbone extensions.

Connections can be made with all standard cable types, even with transfer rates of 40 Gigabit Ethernet/s (40GBase-T), without requiring hours of preparation and the need for special tools. It is particularly cost-effective for connections in data centers where every centimeter counts. Space problems due to surplus cable are consigned to history books. Thanks to its compact design and suitability for multipoint applications, the MFP8 can also be used where space is at an absolute premium.



### Industrial cabling (IP20)

Whether used in industrial control cabinets or distribution boxes in production, the MFP8 plug series can also be relied upon in industry. 360° shielding and full metal housing guarantee secure and reliable data transmission, including 40 Gigabit Ethernet/s and even with outside electrical interference. And the use of full range of cable types with solid or stranded conductors make it an universal product fit for all purposes, whether for PROFINET, EtherCAT, EtherNet/IP or CC-Link.



### Residential cabling

When it comes to home networks or cabling for the home-based office, adhering to a minimum footprint is normally a major requirement, and only very rarely is there an outlet just where one is needed. In order to be able to connect PC, router or printer quickly, easily and cheaply, a plug is needed which can be fitted without special tools to full range of cable types with solid or stranded wires. The MFP8 plug series enables to assemble and customise cables – as and where they are needed – and to establish efficient and reliable connections without spending a great deal of time and money.



# MFP8 Cat.6A

## Four strain relief settings

Suitable for cable diameters from 5.0 mm to 9.0 mm

## 360° shielding

Secure data transmission even with outside electrical interference

## Long release latch

Insertion and withdrawal made easy in confined spaces

## Full metal shielding

Between pairs of wires

## Pre-assembled protection cap

Effective protection of contacts from dirt and damage in transit also whilst cable assembly

## Four-chamber wire manager

Available with colour code T568A, T568B, PROFINET

## Robust zinc die-cast housing

Hardened and tempered finish to prevent outside electrical interference

## Piercing contacts IPC

Suitable for:  
AWG27/7 – 22/7  
AWG26/1 – 22/1  
AWG26/19 – 24/19\*

## Standardised plug interface



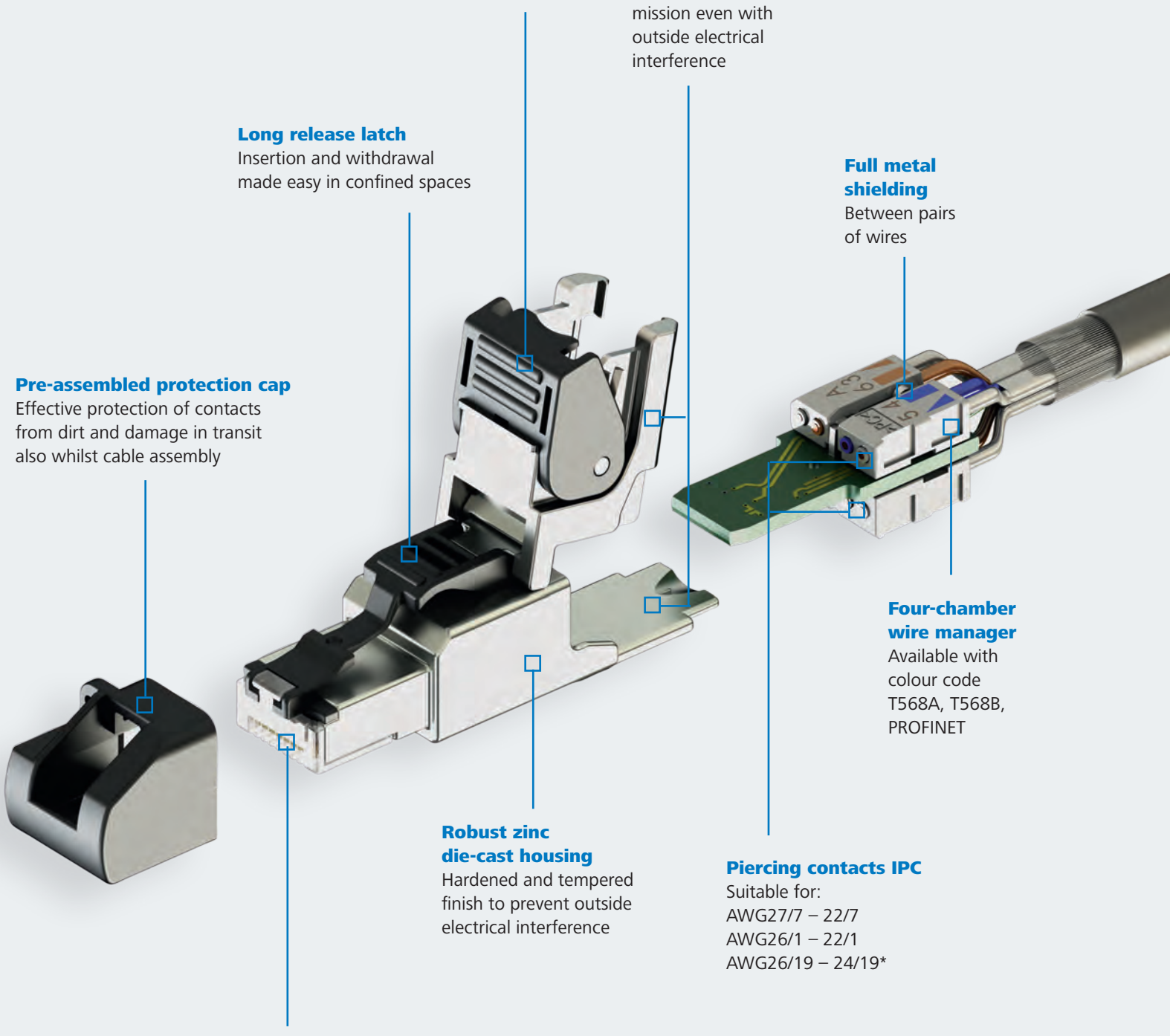





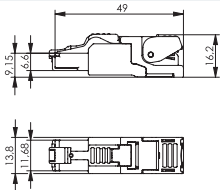

acc. to IEC 60603-7-51

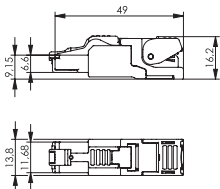

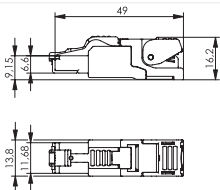
## Specifications MFP8 Cat.6A:

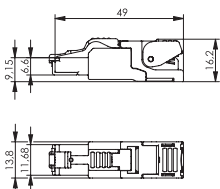
- Category 6A acc. to ISO/IEC 11801
- Plug: IEC 60603-7-51 compliant
- Life:  $\geq 750$  mating cycles
- Contact finish material: Ni1.2Au0.8
- Shielding housing material: die-cast nickel-plated zinc
- **Cu conductor diameter:**  
(J00026A2000, -1, -2, -2110, -2111, -2112)  
solid 0.51 – 0.64 mm (AWG24/1 – 22/1)  
stranded 0.46 – 0.76 mm (AWG27/7 – 22/7)  
stranded 0.61 – 0.78 mm (AWG24/19 – 22/19)\*  
core diameter: 1.0 – 1.6 mm
- **Cu conductor diameter:**  
(J00026A2003, -4, -2113, -2114)  
solid 0.41 – 0.51 mm (AWG26/1 – 24/1)  
stranded 0.46 – 0.61 mm (AWG27/7 – 24/7)  
stranded 0.51 (AWG26/19)\*  
core diameter: 0.85 – 1.1 mm
- Outer diameter: 5.0 – 9.0 mm
- Reusable IPC:  $\leq 4$  cycles
- Temperature range:  $-40^{\circ}\text{C}$  to  $85^{\circ}\text{C}$
- Power over Ethernet plus (PoE+) acc. to IEEE 802.3at
- IP20; UL listed

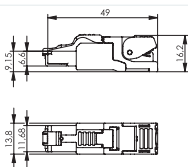
\* approval of cable by Telegärtner Karl Gärtner GmbH required

MFP8 Cat.6A for AWG24-22/1; AWG27-22/7; AWG22/19*	Order no.	Description	PU
 	J00026A2000	MFP8 T568A Cat.6A incl. pre-assembled protection cap AWG24/1 - 22/1, AWG27/7-22/7	1 / 10 in carton
	J00026A2001	MFP8 T568B Cat.6A incl. pre-assembled protection cap AWG24/1 - 22/1, AWG27/7-22/7	1 / 10 in carton
 	J00026A2110	MFP8 T568A Cat.6A incl. pre-assembled protection cap, blister package AWG24/1 - 22/1, AWG27/7-22/7	10
	J00026A2111	MFP8 T568B Cat.6A incl. pre-assembled cap protection, blister package AWG24/1 - 22/1, AWG27/7-22/7	10
MFP8 Cat.6A for AWG26-24/1; AWG27-24/7; AWG26/19*	Order no.	Description	PU
 	J00026A2004	MFP8 T568A Cat.6A incl. pre-assembled protection cap AWG26/1-24/1, AWG27/7-24/7	1 / 10 in carton
	J00026A2003	MFP8 T568B Cat.6A incl. pre-assembled protection cap AWG26/1-24/1, AWG27/7-24/7	1 / 10 in carton
 	J00026A2114	MFP8 T568A Cat.6A incl. pre-assembled protection cap, blister package AWG26/1-24/1, AWG27/7-24/7	10
	J00026A2113	MFP8 T568B Cat.6A incl. pre-assembled protection cap, blister package AWG26/1-24/1, AWG27/7-24/7	10
MFP8 for PROFINET	Order no.	Description	PU
 	J00026A2002	MFP8 PROFINET incl. pre-assembled protection cap	1 / 10 in carton
	J00026A2112	MFP8 PROFINET incl. pre-assembled protection cap, blister package	10
MFP8 Wire Manager	Order no.	Description	PU
	F00020A2130	MFP8 wire manager T568A AWG24/1-AWG22/1, AWG27/7-AWG22/7	30
	F00020A2131	MFP8 wire manager T568B AWG24/1-AWG22/1, AWG27/7-AWG22/7	30
	F00020A2132	MFP8 wire manager PROFINET AWG24/1-AWG22/1, AWG27/7-AWG22/7	30
	F00020A2134	MFP8 wire manager T568A AWG26/1-AWG24/1, AWG27/7-AWG24/7	30
	F00020A2133	MFP8 wire manager T568B AWG26/1-AWG24/1, AWG27/7-AWG24/7	30

\* approval of cable by Telegärtner Karl Gärtner GmbH required

# MFP8-4x90 Cat.6A

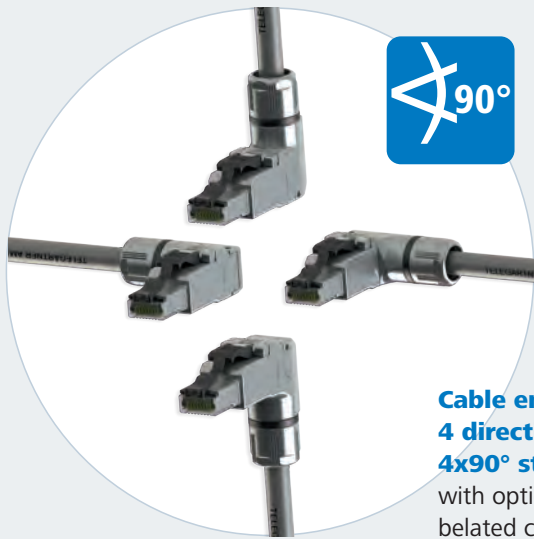

90°

**Cable entry from 4 directions in 4x90° steps**  
with option for belated changes

**360° shielding**  
Secure data transmission even with outside electrical interference

**Four-chamber wire manager**

Available with colour code T568A, T568B, PROFINET

**Long release latch**

Insertion and withdrawal made easy in confined spaces

**Standardised plug interface**

acc. to IEC 60603-7-51

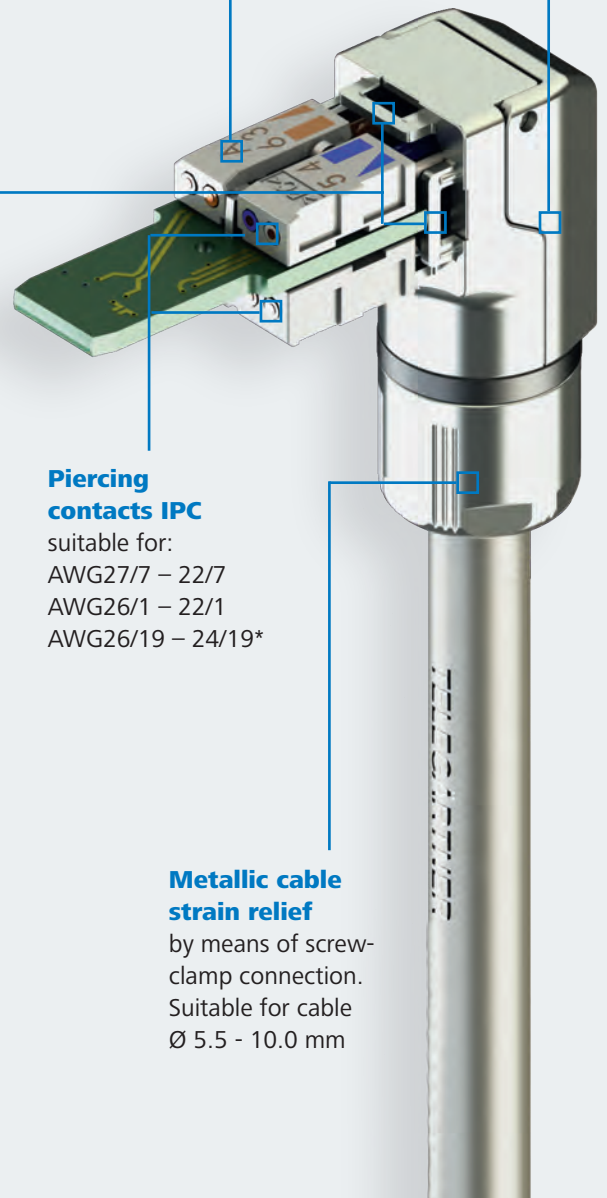

**Piercing contacts IPC**

suitable for:  
AWG27/7 – 22/7  
AWG26/1 – 22/1  
AWG26/19 – 24/19\*

**Robust zinc die-cast housing**

Hardened and tempered finish to prevent outside electrical interference

**Metallic cable strain relief**

by means of screw-clamp connection. Suitable for cable Ø 5.5 - 10.0 mm

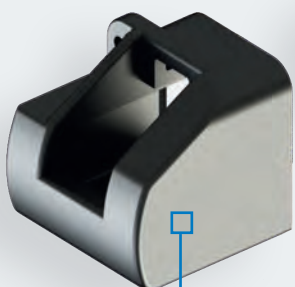

**Pre-assembled protection cap**

Effective protection of contacts from dirt and damage in transit also whilst cable assembly



# MFP8 IE Cat.6A

## Long release latch

Insertion and withdrawal made easy in confined spaces

## 360° shielding

Secure data transmission even with outside electrical interference

## Four-chamber wire manager

Available with colour code T568A, T568B, PROFINET

## Pre-assembled protection cap

Effective protection of contacts from dirt and damage in transit also whilst cable assembly.

## Metallic cable strain relief

by means of screw-clamp connection. Suitable for cable Ø 5.5 mm to 10.0 mm

## Piercing contacts IPC

suitable for:  
AWG27/7 – 22/7  
AWG26/1 – 22/1  
AWG26/19 – 24/19\*

## Robust zinc die-cast housing

Hardened and tempered finish to prevent outside electrical interference

## Standardised plug interface



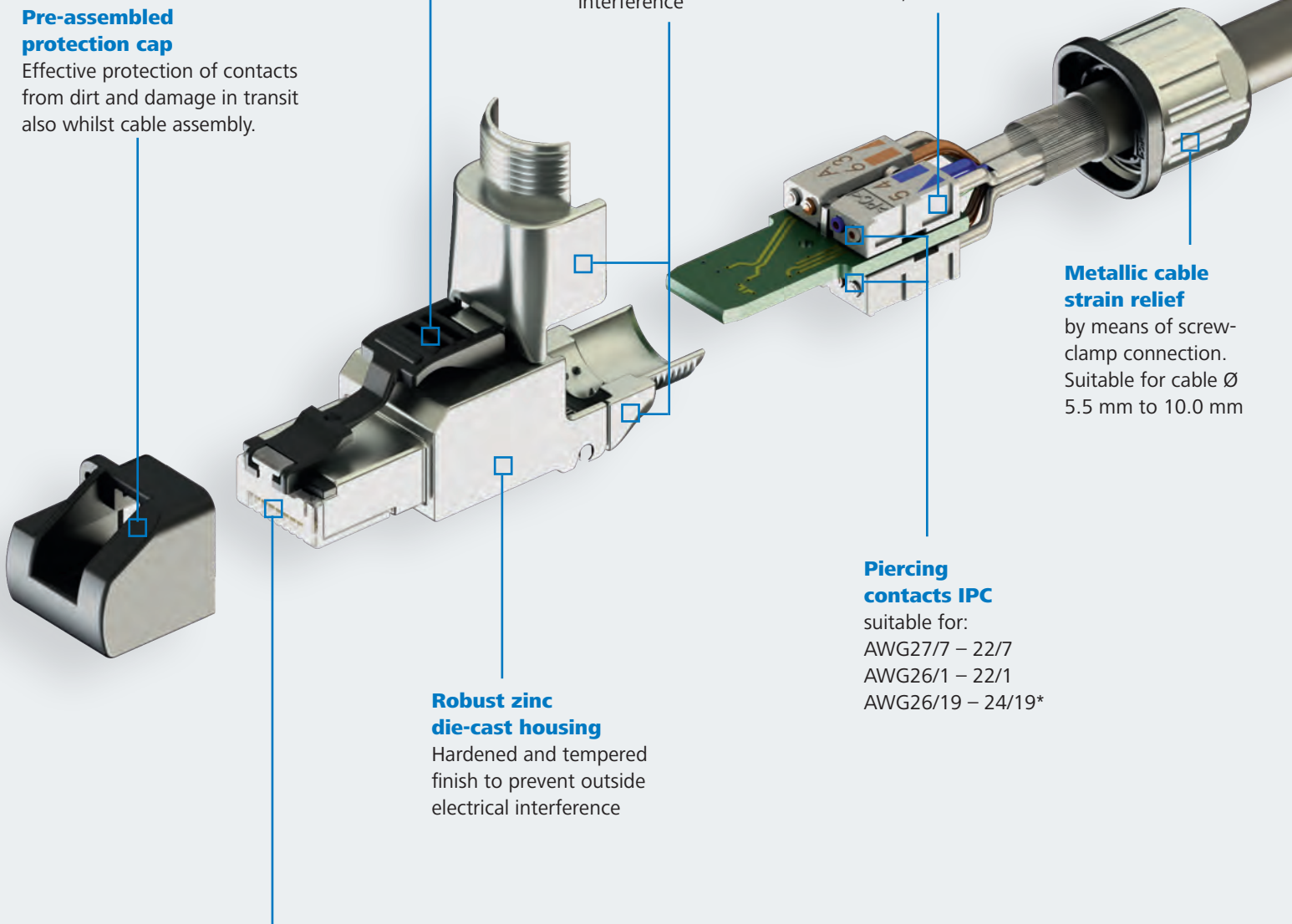





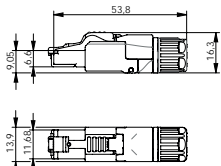

acc. to IEC 60603-7-51

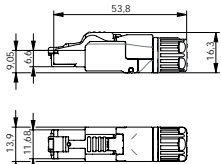

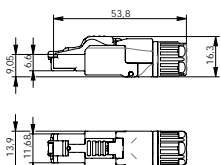

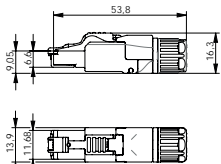
## Specifications MFP8 IE Cat.6A:

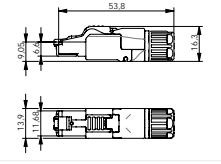
- Category 6<sub>A</sub> acc. to ISO/IEC 11801
- Plug: IEC 60603-7-51 compliant
- Life: ≥ 750 mating cycles
- Contact finish material: Ni1.2Au0.8
- Shielding housing material: die-cast nickel-plated zinc
- **Cu conductor diameter:**  
(J00026A5000, -1, -2, -5110, -5111, -5112)  
solid 0.51 – 0.64 mm (AWG24/1 – 22/1)  
stranded 0.46 – 0.76 mm (AWG27/7 – 22/7)  
stranded 0.61 – 0.78 mm (AWG24/19 – 22/19)\*  
core diameter: 1.0 – 1.6 mm
- **Cu conductor diameter:**  
(J00026A5003, -4, -5113, -5114)  
solid 0.41 – 0.51 mm (AWG26/1 – 24/1)  
stranded 0.46 – 0.61 mm (AWG27/7 – 24/7)  
stranded 0.51 (AWG26/19)\*  
core diameter: 0.85 – 1.1 mm
- Outer diameter: 5.5 – 10.0 mm
- Reusable IPC: ≤ 4 cycles
- Temperature range: -40°C to 85°C
- Power over Ethernet plus (PoE+) acc. to IEEE 802.3at
- IP20
- Cable strain relief: AF13

MFP8 IE Cat.6 <sub>A</sub> for AWG24-22/1; AWG27-22/7; AWG22/19*	Order no.	Description	PU
 	J00026A5000	MFP8 IE T568A Cat.6 <sub>A</sub> incl. pre-assembled protection cap AWG24/1 - 22/1, AWG27/7-22/7	1 / 10 in carton
	J00026A5001	MFP8 IE T568B Cat.6 <sub>A</sub> incl. pre-assembled protection cap AWG24/1 - 22/1, AWG27/7-22/7	1 / 10 in carton
 	J00026A5110	MFP8 IE T568A Cat.6 <sub>A</sub> incl. pre-assembly protection cap, blister package AWG24/1 - 22/1, AWG27/7-22/7	10
	J00026A5111	MFP8 IE T568B Cat.6 <sub>A</sub> incl. pre-assembly protection cap, blister package AWG24/1 - 22/1, AWG27/7-22/7	10
MFP8 IE Cat.6 <sub>A</sub> for AWG26-24/1; AWG27-24/7; AWG26/19*	Order no.	Description	PU
 	J00026A5004	MFP8 IE T568A Cat.6 <sub>A</sub> incl. pre-assembled protection cap AWG26/1-24/1, AWG27/7-24/7	1 / 10 in carton
	J00026A5003	MFP8 IE T568B Cat.6 <sub>A</sub> incl. pre-assembled protection cap AWG26/1-24/1, AWG27/7-24/7	1 / 10 in carton
 	J00026A5114	MFP8 IE T568A Cat.6 <sub>A</sub> incl. pre-assembly protection cap, blister package AWG26/1-24/1, AWG27/7-24/7	10
	J00026A5113	MFP8 IE T568B Cat.6 <sub>A</sub> incl. pre-assembly protection cap, blister package AWG26/1-24/1, AWG27/7-24/7	10
MFP8 IE for PROFINET	Order no.	Description	PU
 	J00026A5002	MFP8 IE PROFINET incl. pre-assembled protection cap	1 / 10 in carton
	J00026A5112	MFP8 IE PROFINET incl. pre-assembled protection cap blister package	10
MFP8 Wire Manager	Order no.	Description	PU
	F00020A2130	MFP8 wire manager T568A AWG24/1-AWG22/1, AWG27/7-AWG22/7	30
	F00020A2131	MFP8 wire manager T568B AWG24/1-AWG22/1, AWG27/7-AWG22/7	30
	F00020A2132	MFP8 wire manager PROFINET AWG24/1-AWG22/1, AWG27/7-AWG22/7	30
	F00020A2134	MFP8 wire manager T568A AWG26/1-AWG24/1, AWG27/7-AWG24/7	30
	F00020A2133	MFP8 wire manager T568B AWG26/1-AWG24/1, AWG27/7-AWG24/7	30

\* approval of cable by Telegärtner Karl Gärtner GmbH required

# MFP8 Cat.8.1

## Long release latch

Insertion and withdrawal made easy in confined spaces

## 360° shielding

Secure data transmission even with outside electrical interference

## Four-chamber wire manager

Available with colour code T568B

## Pre-assembled protection cap

Effective protection of contacts from dirt and damage in transit also whilst cable assembly.

## Metallic cable strain relief

by means of screw-clamp connection. Suitable for cable Ø 5.5 mm to 10.0 mm

## Piercing contacts IPC

suitable for:  
AWG27/7 – 22/7  
AWG26/1 – 22/1

## Robust zinc die-cast housing

Hardened and tempered finish to prevent outside electrical interference

## Standardised plug interface

acc. to IEC 60603-7-81

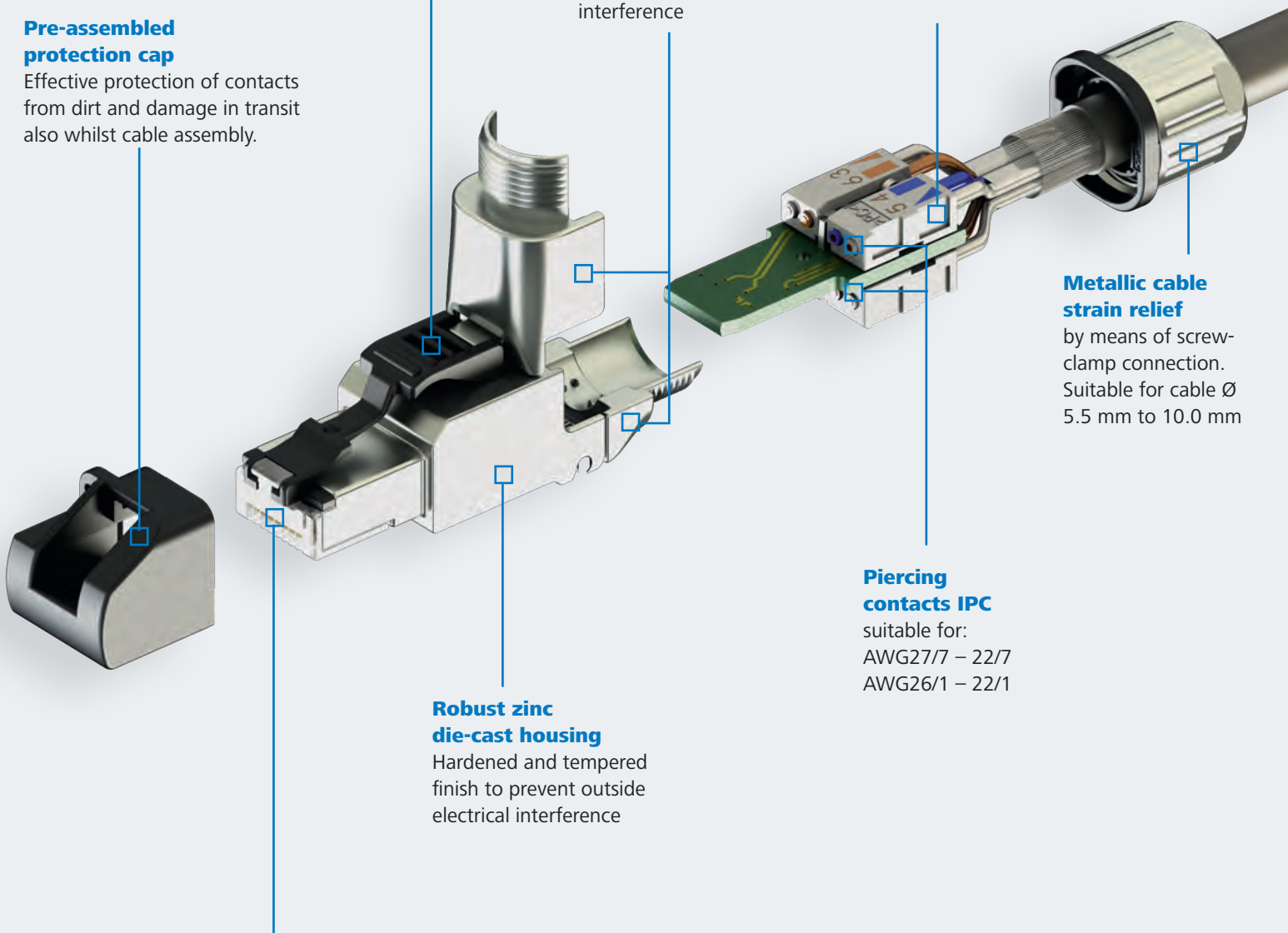

### Specifications MFP8 Cat.8.1:

- Category 8.1 acc. to ISO/IEC 11801
- Plug: IEC 60603-7-81 compliant
- Life:  $\geq 750$  mating cycles
- Contact finish material: Ni1.2Au0.8
- Shielding housing material: die-cast nickel-plated zinc
- **Cu conductor diameter:**  
(J00026A5005)  
solid 0.51 – 0.64 mm (AWG24/1 – 22/1)  
stranded 0.46 – 0.76 mm (AWG27/7 – 22/7)  
core diameter: 1.0 – 1.6 mm
- **Cu conductor diameter:**  
(J00026A5007)  
solid 0.41 – 0.51 mm (AWG26/1 – 24/1)  
stranded 0.46 – 0.61 mm (AWG27/7 – 24/7)  
core diameter: 0.85 – 1.1 mm
- Outer diameter: 5.5 – 10.0 mm
- Reusable IPC:  $\leq 4$  cycles
- Temperature range: -40°C to 85°C
- Power over Ethernet plus (PoE+) acc. to IEEE 802.3at
- IP20
- Cable strain relief: AF13

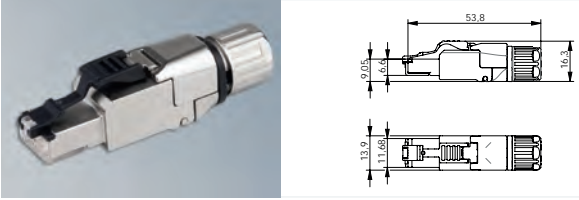
MFP8 Cat.8.1 for AWG24-22/1; AWG27-22/7	Order no.	Description	PU
	J00026A5005	MFP8 T568B Cat.8.1 incl. pre-assembled protection cap AWG24 - 22/1, AWG27 - 22/7	1 / 10 in carton
	J00026A5007	MFP8 T568B Cat.8.1 incl. pre-assembled protection cap AWG26 - 24/1, AWG27 - 24/7	1 / 10 in carton

# Other Telegärtner products for industrial premises and machinery cabling

## Industrial Ethernet connector STX



Whether it involves factory, machinery or facility cabling: With the industrial connectors of Variant 1, Variant 4, Variant 5 and Variant 14 from the STX platform and industrial connectors of Variant 6 Telegärtner offers you top class standard compliant Industrial Ethernet solutions.

The STX platform concept for industrial connectors enables the use of inserts with identical dimensions in different housings. There is nothing easier and at the same time more reliable for modern, future proof 10 Gbit networks for industrial premises.

More information and a detailed list of products can be found at

[www.telegaertner.com/en/stx](http://www.telegaertner.com/en/stx)

## DataVoice Industry catalogue



All Telegärtner network components for the industrial sector can be found in our DataVoice Industry catalogue. Download or order at [www.telegaertner.com](http://www.telegaertner.com)

## Online catalogue

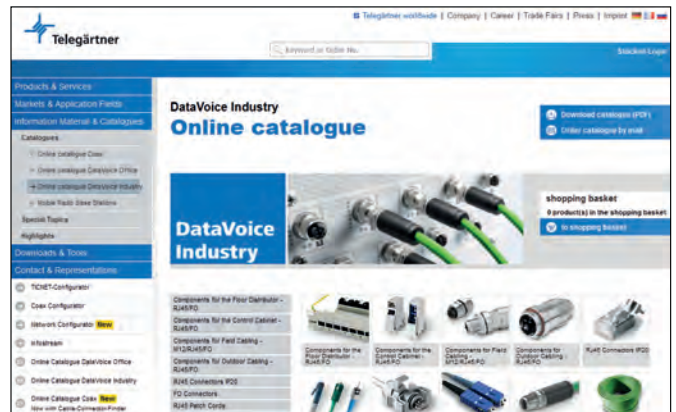

All products can be downloaded our online catalogue at

[www.telegaertner.com](http://www.telegaertner.com)

**Telegärtner  
Karl Gärtner GmbH**

Lerchenstr. 35  
71144 Steinbronn / Germany

Telefon: +49 71 57/1 25-0  
Telefax: +49 71 57/1 25-5120

E-Mail: [info@telegaertner.com](mailto:info@telegaertner.com)  
Web: [www.telegaertner.com](http://www.telegaertner.com)

Your distributor: