

Test Fixture

LCR-10A

QUICK START GUIDE

GW INSTEK PART NO. 82CR-10A00M01



ISO-9001 CERTIFIED MANUFACTURER

GW INSTEK

This manual contains proprietary information, which is protected by copyright. All rights are reserved. No part of this manual may be photocopied, reproduced or translated to another language without prior written consent of Good Will Corporation.

The information in this manual was correct at the time of printing. However, Good Will continues to improve its products and therefore reserves the right to change the specifications, equipment, and maintenance procedures at any time without notice.

Good Will Instrument Co., Ltd. No. 7-1, Jhongsing Rd., Tucheng Dist., New Taipei City 236, Taiwan.

7	Pressure Stick	The pressure stick is made of ceramic material and used to fix DUT downward for measurement	1
8	Fixing Mount	The mount fixing both measured circuit and electrode	1
9	Fixing Plate	The plate fixing both electrode and DUT slide	1
10	Location Pillar	The pillars locating fixing plate on top of fixing mount	2
11	2-wire Measuring Electrode Plate	The 2-wire measuring electrode plate	1
12	4-wire Measuring Electrode Plate	The 4-wire measuring electrode plate used for mΩ measurement.	1
13	STD LOAD	The HF LOAD of Standard resistor 100Ω (1206) for calibration	10
14	SHORT BAR	The SHORT Correction for calibration	1
15	L-Shape Bracket	It can be fixed to test fixture main body to raise stability when test fixture is under test, further reducing BNC improper force	1
16	Slide	It helps fixing DUT in the central point of pressure stick. It is only available for 2-wire measuring electrode plate, 2.5mm round and 3.5/4.5/5.5/6.5/7.5mm square plates	6

③

INSTALLATION

- Turn the both fixing handles of BNC terminals from LCR-10A test fixture toward left side until the gap of BCN external sleeve faces upward.
- Align the gap with the salient point of BNC terminal from LCR test instrument and insert it firmly into place. Turn the both fixing handles of BNC terminals from LCR-10A test fixture toward right side until the external sleeve of BCN is fixed stably into place.

Note: When the L-shape bracket is employed, take off the nut from the ground terminal prior to test fixture installation. Follow the steps above for proper installation followed by fastening the nut so that the test fixture can be held tightly when DUT is inserted.

Note: Refer to the pictures below for details of L-shape bracket installation.

Fixture Installation

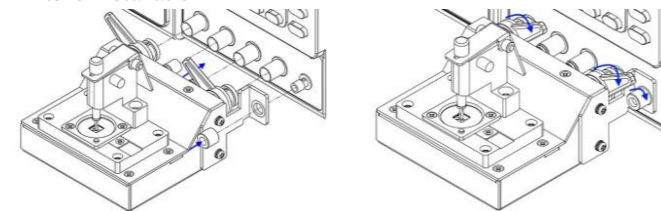

L-shape Bracket Installation

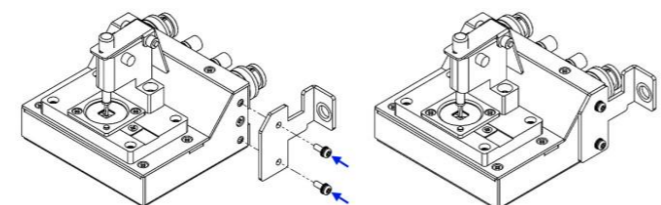

④

OVERVIEW

The LCR-10A Test Fixture for bottom electrode components.

Specifications

Model	LCR-10A
DUT Connector	2-Terminal, 4-Terminal
Measurement Frequency	DC to 30MHz
Maximum Voltage	±45V Peak max.(AC+DC)
Application size	0402 – 2512 (≦8Wx8Dx7H mm)
Pressure of Pressure stick	600 – 1200 g
Dimensions	91W x 80H x 98D mm
Weight	237g
Operating Environment	0–50°C, <70%RH

Additional error(with open & short correction)		f:[MHz]
Proportional error	$0.5 \times (f/10)^2$ [%]	
Open repeatability	$0.01 + 1 \times (f/10)$ [μS]	
Short repeatability, 2 wire	$30 + 40 \times (f/10)$ [mΩ]	
Short repeatability, 4 wire	$2 + 70 \times (f/10)$ [mΩ]	

①

Fix/Release Pressure Stick

When replacing DUT and measuring plate or executing OPEN Correction, it is suggested to fix the pressure stick upwards to save energy and prevent from accidental damages caused by pressure stick collision.

- Press the push pad to lift the pressure stick and push the aligning Pin toward left side into place so that the aligning pin will protrude from the other side.
- Release the push pad gently so that the aligning pin will be with withheld by push pad stop plate firmly.
- While releasing the push pad, first hold the aligning pin followed by pressing the push pad slightly so that the push pad stop plate will be lifted. Further fully release the aligning pin and then the push pad.

Note: It is requested to gently maneuver while operating the push pad in case of damages to parts due to spring rebound from improper operations.

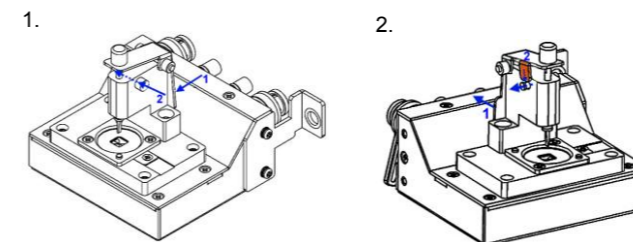

⑤

Fixture Overview

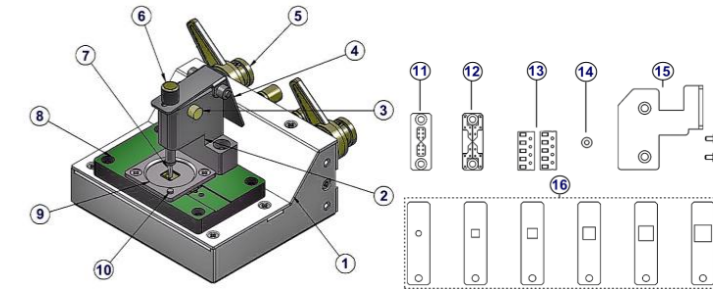

Index	Item	Description	Quantity
1	Test Fixture Main Body	The main body of test fixture	1
2	Pressure Stick Bracket	The main structure embedded with pressure stick	1
3	Pressure Stick Aligning Pin	The aligning pin fixing pressure stick within certain position. It is available when replacing DUT	1
4	Push Pad	It controls pressure stick upwards or downwards	1
5	BNC Fixing Handles	It fastens or loosens terminals between BNC and instrument. Turn right to fix, whilst turn left to loosen	4/2
6	Pressure Stick Adjusting Button	It is used to adjust position when pressure stick is pushed down. The measuring electrode below is the target point for adjustment.	1

②

Measuring Electrode Plate/Slide Installation

It is available to replace a corresponding slide for measuring DUT in differed sizes so that DUT can be positioned in the central point for accurate measurement. When operating measurement of minor resistance value (mΩ), please utilize 4-wire measuring electrode plate for a better precise measurement.

- Loosen the screws of fixing plate and pull the fixing plate out of from the location pillars.
- Place the 2-wire or 4-wire measuring electrode plate onto the fixing mount followed by tightening the screws.
- Place the slide above the 2-wire measuring electrode plate followed by fixing the screws.
- Restore the fixing plate back by pushing down to the location pillars followed by fastening the screws.

Note: While replacing electrode plate or slide, it is recommended to separate the test fixture from LCR Meter for individual operation. It is requested to gently maneuver while operating the push pad in case of damages to parts due to spring rebound from improper operations.

When installing 4-wire measuring electrode plate, it is Not allowed to install slide in case of damages to electrode.

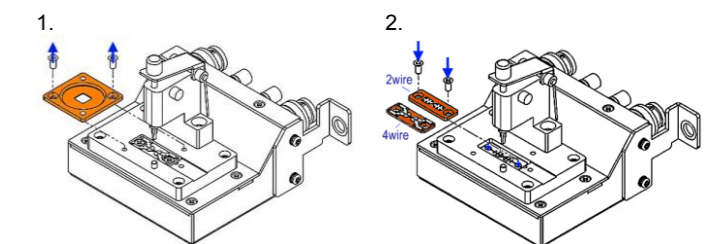

⑥

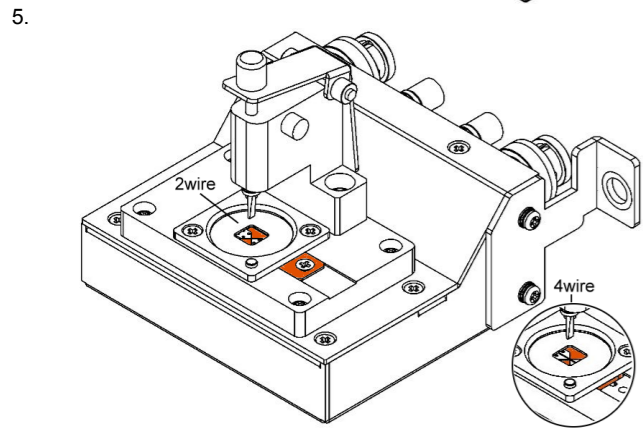
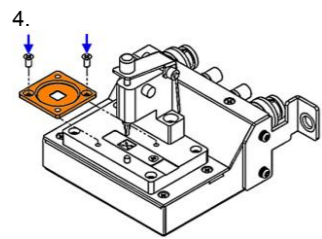
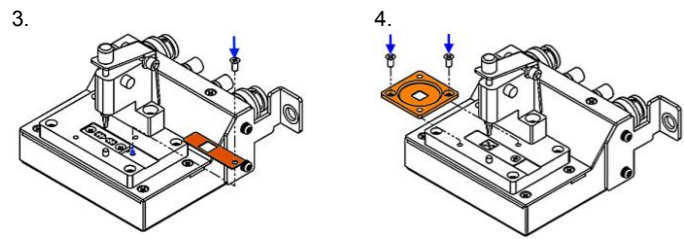

MEASUREMENT

WARNING Before measurement, be sure to read the operating instructions to avoid danger.

1. Set measuring conditions with parameters, and install LCR-10A test fixture.
2. Execute the CORRECTION mode. Set LCR-10A for the FIXTURE COMPENSATION item in order to execute LCR-10A parameter compensation, by which the CABLE LENGTH item will be unavailable. On the other hand, when extension cable is wired with LCR-10A for measurement, it is required to disable the FIXTURE COMPENSATION item (OFF) and instead select an appropriate option for CABLE LENGTH corresponding to the employed cable.



3. Lift the pressure stick and fix it upwards. Execute the OPEN CORRECTION and the OPEN item will change from OFF to ON.

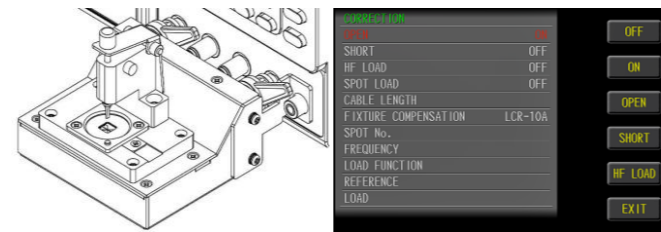

⑦

⑧

4. When pressure stick is withheld upwards, place the Short Bar in the central point of measuring electrode plate with recession facing upwards. Align the pressure stick with the Short Bar gently followed by pushing down the pressure stick into place so that the Short Bar, which contacts H/L 2-sides electrode plate, completes the short-circuit state. Execute the SHORT CORRECTION and the SHORT item will change from OFF to ON.

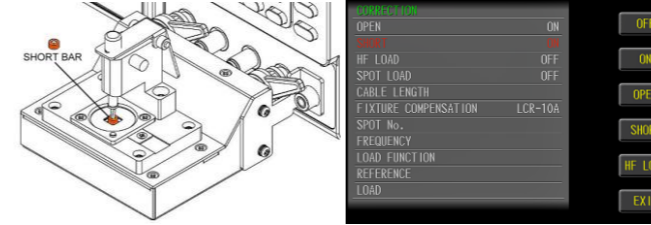

5. It is suggested to execute HF LOAD calibration when test frequency is greater than 3MHz. When pressure stick is withheld upwards, place the STD LOAD in the central point of measuring electrode plate. Align the pressure stick with the STD LOAD gently followed by pushing down the pressure stick into place so that the electrode of STD LOAD contacts H/L 2-sides electrode plate. Execute the HF LOAD CORRECTION and the HF LOAD item will change from OFF to ON.

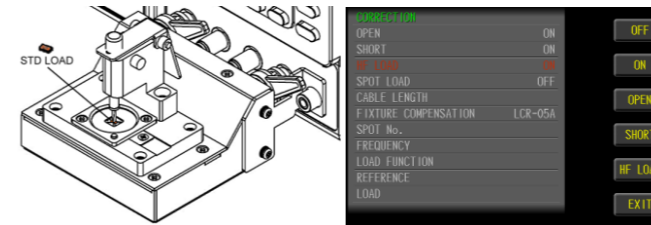

⑨

6. When pressure stick is withheld upwards, place the DUT in the central point of measuring electrode plate. Align the pressure stick with the DUT gently followed by pushing down the pressure stick into place so that the electrode of DUT contacts H/L 2-sides electrode plate for measurement. The latest calibration status will be shown in the bottom of the LCD display (item and measuring cable length or test fixture model).

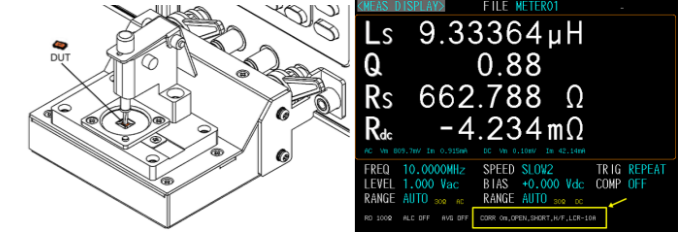

7. Remove the component from the test fixture.

Note: DUT is supposed to be placed in the central point of measuring electrode plate. Do not tilt or skew it in case of measurement errors.

It is requested to gently maneuver while operating the pressure stick in case of damages to DUT due to accidental falling off by pressure stick.

The electrode of 4-wire measuring electrode plate is far from flat. Hence, place DUT gently in case of damages.

If DUT is made of fragile material, e.g., glass or easy-distortion soft material, please handle with caution at your own risk.

⑩